

# OWNER'S MANUAL

**MODEL NO.'s**  
**HPD-16**  
**HPD-20**



## **CAUTION**

For Safe Operation  
Read Rules And  
Instructions Carefully

**SINO LEEINGLES, PIDA AYUDA  
A AIGUIEN QUE SI LO LEA  
PARA QUE LE TRADUZCA LAS  
MEDIDAS DE SEGURIDAD.**

## **STATEMENT OF POLICY**

It is the policy of Worksaver, Inc. to improve its products where it is possible and practical to do so. Worksaver, Inc. reserves the right to make changes or improvements in design and construction at any time, without incurring the obligation to make these changes on previously manufactured units.

# **3-PT. HYDRAULIC POST DRIVER**

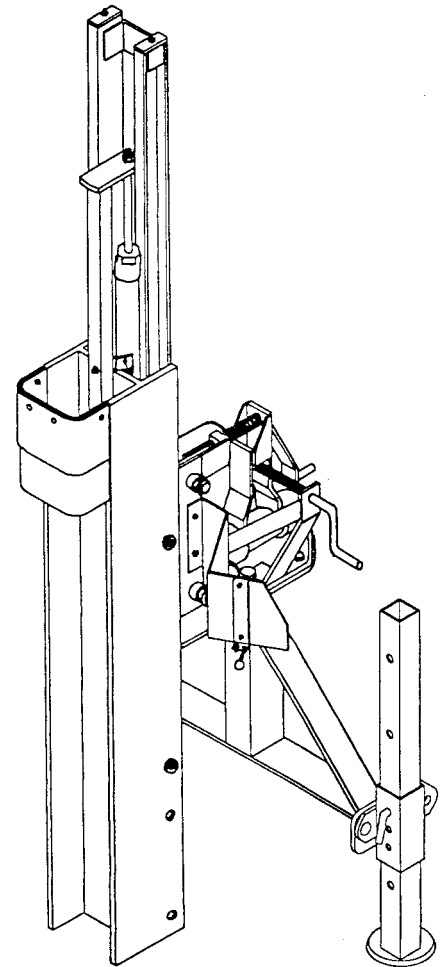

**Safety Instructions**  
**Tractor Preparation**  
**Operating Instructions**  
**Assembly & Mounting**  
**Maintenance**  
**Repair Parts**

Shown with Optional  
Adjustable Leg Package



## **CAUTION**

**THE FOLLOWING SAFETY PRECAUTIONS SHOULD BE THOROUGHLY UNDERSTOOD  
BEFORE ATTEMPTING TO BEGIN ASSEMBLING THIS MACHINE**

1. Select an area for assembly that is clean and free of any debris which might cause persons working on the assembly to trip.
2. Do not lift heavy parts or assemblies. Use crane, jack, tackle, fork trucks or other mechanical devices.
3. Preview the assembly instructions in your operator's manual before proceeding further.
4. If the assembly instructions call for parts or assemblies to be blocked up, use only blocking material that is in good condition and is capable of handling the weight of the assembly to be blocked. Also insure that the blocking material is on a clean, dry surface.
5. Never put hands, or any part of body, under blocked up assemblies if at all possible.
6. After completing assembly, thoroughly inspect the machine to be sure that all nuts, bolts, hydraulic fittings or any other fastened assemblies have been thoroughly tightened.
7. Before operating the machine, thoroughly read the operation section of your operator's manual.
8. Before operating, read the maintenance section of your operator's manual to be sure that any parts requiring lubrication, such as gearboxes, are full, to avoid any possible damage.
9. **Before operating equipment – If you have any questions regarding the proper assembly or operation, contact your dealer or representative.**

# To the Owner/Operator/Dealer

All implements with moving parts are potentially hazardous. There is no substitute for a cautious, safe-minded operator who recognizes the potential hazards and follows reasonable safety practices. The manufacturer has designed this implement to be used with all its safety equipment properly attached to minimize the chance of accidents.

## BEFORE YOU START!!

Read the safety messages on the implement and shown in your manual.  
Observe the rules of safety and common sense!



### THIS SYMBOL MEANS

- ATTENTION!
- BECOME ALERT!
- YOUR SAFETY IS INVOLVED!

THIS SAFETY ALERT SYMBOL IDENTIFIES IMPORTANT SAFETY WARNING MESSAGES. CAREFULLY READ EACH WARNING MESSAGE THAT FOLLOWS. FAILURE TO UNDERSTAND AND OBEY A SAFETY WARNING, OR RECOGNIZE A SAFETY HAZARD, COULD RESULT IN AN INJURY OR DEATH TO YOU OR OTHERS AROUND YOU. THE OPERATOR IS ULTIMATELY RESPONSIBLE FOR THE SAFETY OF HIMSELF, AS WELL AS OTHERS, IN THE OPERATING AREA OF THE TRACTOR AND ATTACHED EQUIPMENT.

---

## UNDERSTAND SIGNAL WORDS

Note the use of the signal words **DANGER**, **WARNING** and **CAUTION** with the safety messages. The appropriate signal word for each has been selected using the following guidelines:

**DANGER:** Indicates an imminently hazardous situation that, if not avoided, will result in death or serious injury. This signal word is to be limited to the most extreme situations typically for machine components which, for functional purposes, cannot be guarded.

**WARNING:** Indicates a potentially hazardous situation that, if not avoided, could result in death or serious injury, and includes hazards that are exposed when guards are removed. It may also be used to alert against unsafe practices.

**CAUTION:** Indicates a potentially hazardous situation that, if not avoided, may result in minor or moderate injury. It may also be used to alert against unsafe practices.

If you have questions not answered in this manual or require additional copies or the manual is damaged, please contact your dealer or the manufacturer directly.

---

## IMPORTANT SAFETY INFORMATION!

Working with unfamiliar equipment can lead to careless injuries. Read this manual, and the manual for your tractor, before assembly or operating, to acquaint yourself with the machines. It is the Post Driver owner's responsibility, if this machine is used by any person other than yourself, is loaned or rented, to make certain that the operator, prior to operating:

1. Reads and understands the operator's manuals.
2. Is instructed in safe and proper use.



The use of this equipment is subject to certain hazards which cannot be protected against by mechanical means or product design. All operators of this equipment must read and understand this entire manual, paying particular attention to safety and operating instructions, prior to using. If there is something in this manual you do not understand, ask your supervisor, or your dealer, to explain it to you.













Most accidents occur because of neglect or carelessness. Keep all helpers and bystanders twenty-five feet (25') from an operating driver. Only properly trained people should operate this machine. It is recommended the tractor be equipped with a Rollover Protection System (ROPS) and a seat belt that is used. Always engage parking or place transmission in "Park" before dismounting tractor. Never leave equipment unattended with the tractor running.

# SAFETY INSTRUCTIONS (continued)



## EQUIPMENT SAFETY GUIDELINES

-  Safety of the operator is one of the main concerns in designing and developing a new piece of equipment. Designers and manufacturers build in as many safety features as possible. However, every year many accidents occur which could have been avoided by a few seconds of thought and a more careful approach to handling equipment. You, the operator, can avoid many accidents by observing the following precautions in this section. To avoid personal injury, study the following precautions and insist those working with you, or for you, follow them.
  
-  In order to provide a better view, certain photographs or illustrations in this manual may show an assembly with a safety shield removed. However, equipment should never be operated in this condition. Keep all shields in place. If shield removal becomes necessary for repairs, replace the shield prior to use.
  
-  Replace any CAUTION, WARNING, DANGER or instruction safety sign that is not readable or is missing. Location of such safety signs is indicated in this booklet.
  
-  Never use alcoholic beverages or drugs which can hinder alertness or coordination while operating this equipment. Consult your doctor about operating this machine while taking prescription medications.
  
-  Review the safety instructions with all users annually.
  
-  This equipment is dangerous to children and persons unfamiliar with its operation. The operator should be a responsible adult familiar with farm machinery and trained in this equipment's operations. **Do not allow persons to operate or assemble this unit until they have read this manual and have developed a thorough understanding of the safety precautions and of how it works.**
  
-  To prevent injury or death, use a tractor equipped with a Roll-Over Protective System (ROPS). Do not paint over, remove or deface any safety signs or warning signs on your equipment. Observe all safety signs and practice the instruction on them.
  
-  Never exceed the limits of a piece of machinery. If its ability to do a job, or to do so safely, is in question - **DON'T TRY IT.**
  
-  Do not modify the equipment in any way. Unauthorized modification may impair the function and/or safety and could affect the life of the equipment.
  
-  In addition to the design and configuration of this implement, including Safety Signs and Safety Equipment, hazard control and accident prevention are dependent upon the awareness, concern, prudence, and proper training of personnel involved in the operation, transport, maintenance, and storage of the machine. Refer also to Safety Messages and Operation Instructions in each of the appropriate sections of the Tractor and Post Driver Manuals. Pay close attention to the Safety Signs affixed to the Tractor and the Post Driver.

## SAFETY INSTRUCTIONS (continued)



### SAFETY SIGNS



Keep safety signs clean and legible at all times.



Replace safety signs that are missing or have become illegible.



Replaced parts that displayed a safety sign should also display the current sign.



Safety signs are available from your Distributor or Dealer Parts Department or the factory.

### **How to Install Safety Signs:**

- Be sure that the installation area is clean and dry.
- Be sure temperature is above 50°F (10°C).
- Decide on the exact position before you remove the backing paper.
- Remove the smallest portion of the split backing paper.
- Align the sign over the specified area and carefully press the small portion with the exposed sticky backing in place.
- Slowly peel back the remaining paper and carefully smooth the remaining portion of the sign in place.
- Small air pockets can be pierced with a pin and smoothed out using the piece of sign backing paper.



### PREPARATION



Never operate the tractor and post driver until you have read and completely understand this manual, the Tractor Operator's Manual, and each of the Safety Messages found on the safety signs on the tractor and post driver.



Personal protection equipment including hard hat, safety glasses, safety shoes, and gloves are recommended during assembly, installation, operation, adjustment, maintaining, repairing, removal, or moving the implement. Do not allow long hair, loose fitting clothing or jewelry to be around moving parts.



#### **PROLONGED EXPOSURE TO LOUD NOISE MAY CAUSE PERMANENT HEARING LOSS!**

Tractors with or without attachments can often be noisy enough to cause permanent, partial hearing loss. We recommend that you wear hearing protection on a full-time basis if the noise in the Operator's position exceeds 80db. Noise over 85db on a long-term basis can cause severe hearing loss. Noise over 90db adjacent to the Operator over a long-term basis may cause permanent, total hearing loss. **NOTE:** Hearing loss from loud noise (from tractors, chain saws, radios, and other such sources close to the ear) is cumulative over a lifetime without hope of natural recovery.



Ensure post driver is properly mounted, adjusted and in good operating condition.

## SAFETY INSTRUCTIONS (continued)



Please remember it is important that you read and heed the safety signs on the post driver, and the safety rules set forth. Clean or replace all safety signs if they cannot be clearly read and understood. They are there for your safety as well as the safety of others. The safe use of this machine is strictly up to you, the operator.



All things with moving parts are potentially hazardous. There is no substitute for a cautious, safe-minded operator who recognizes potential hazards and follows reasonable safety practices. The manufacturer has designed this driver to be used with all its safety equipment properly attached, to minimize the chance of accidents. Study this manual to make sure you have all safety equipment attached.



Make sure that all operating and service personnel know that in the event hydraulic fluid penetrates the skin, it must be surgically removed within a few hours by a doctor familiar with this form of injury, or gangrene may result.



If a safety shield or guard is removed for any reason, it must be replaced before the machine is again operated.



Before servicing the machine, engage the parking brake or place the transmission in "Park", shut off the tractor and remove the key. Relieve all hydraulic pressure in lines.



When the use of hand tools is required to perform any part of assembly, installation, adjustment, maintaining, repairing, removal, or moving the driver, be sure the tools used are designed and recommended by the tool manufacturer for that specific task.



Personal protection equipment including hard hat, safety glasses, safety shoes, and gloves are recommended during assembly, installation, operation, adjustment, maintaining, repairing, removal, or moving the driver. Do not allow long hair, loose fitting clothing or jewelry to be around moving parts.



Always use two people to handle heavy, unwieldy components during assembly, installation, removal, or moving the driver.



Never place any part of your body where it would be in danger if movement should occur during assembly, installation, operation, maintaining, repairing, removal, or moving the driver.



Never place yourself between the tractor and post driver while implement is in operation.



Do not walk or work under a raised driver ram unless it is securely blocked or held in position. Do not depend on the tractor hydraulic system to hold the driver ram in place.



Never leave post driver ram in the raised position. Always lower ram to the ground or to the transport position and install the transport lock pin before transporting or storing.

















A heavy load can cause instability of the tractor. Use extreme care during travel. Slow down on turns and watch out for bumps. The tractor may need front counter-weights to counter-balance the weight of the driver.



Do not allow riders on the driver or tractor at any time. There is no safe place for any riders.

## SAFETY INSTRUCTIONS (continued)















-  Before you operate the driver, check over all pins, bolts and connections to be sure all are securely in place. Replace any damaged or worn parts immediately.
-  Consult local utility companies to make certain there are no buried gas lines, electrical cables, etc., in the work area before beginning operation.
-  Do not allow anyone who is not familiar with the safety rules and operation instructions to use this Post Driver.
-  Never allow children to operate or be around this Post Driver.
-  Use stabilizer bars, adjustable sway chains, or sway blocks on your tractor lift arms to keep the Post Driver from swinging side to side. Adjust as tightly as practical for best performance.
-  Clear the work area of objects which might cause operator to trip or fall.
-  Do not operate post driver on steep hillsides. When installing posts on uneven or hilly terrain, position the tractor with the post driver uphill. This way if any movement of the tractor should occur, it will be away from the post driver operator.
-  Never position the post by hand. Always use Post Holder Tool.
-  Watch out for low overhead electrical wires and limbs when operating or transporting the post driver. Check clearance of doorways when entering a building.
-  Be sure post is cut "SQUARE" on top. Angle cut post can "KICK OUT" of driver and injure the operator.
-  Install transport lock pin and pin clip before transporting or storing the post driver. NEVER INSERT FINGER IN TRANSPORT PIN HOLE TO CHECK ALIGNMENT. Finger could be sheared off if driving ram moves.
-  Keep hands, feet, hair, jewelry, and clothing, away from all moving parts.
-  Do not operate the Post Driver without all safety shields and guards in place.
-  When using a unit, a minimum 20% of tractor and equipment weight must be on tractor front wheels. Without this weight, tractor could tip over, causing personal injury or death. The weight may be attained with a front end loader, front wheel weights, ballast in tires of front tractor weights. When attaining a minimum 20% of tractor and equipment weight on the front wheels, you must not exceed the ROPS weight certification. Weigh the tractor and equipment. Do not guess or estimate!
-  Always use care when operating a Post Driver.

# ALWAYS OBEY SAFETY WARNINGS!

## SAFETY INSTRUCTIONS (continued)















### TRANSPORT SAFETY

-  Comply with state and local laws governing highway safety and movement of farm machinery on public roads.
-  The use of flashing amber lights is acceptable in most localities. However, some localities prohibit their use. Local laws should be checked for all highway lighting and marking requirements.
-  When driving the tractor and equipment on the road or highway under 20 mph (32 kph) at night or during the day, use flashing amber warning lights and a slow moving vehicle (SMV) identification emblem.
-  Always be sure the implement is in the proper raised position for transport.
-  Reduce speed when transporting mounted implements to avoid bouncing and momentary loss of steering control.
-  Plan your route to avoid heavy traffic.
-  Always install transport locks, pins or brackets before transporting.
-  Do not drink and drive!
-  Watch for traffic when operating near or crossing roadways.
-  Turn curves or go up or down hills only at a low speed and at a gradual steering angle. Make certain that at least 20% of the tractor's weight is on the front wheels to maintain safe steerage. Slow down on rough or uneven surfaces, and loose gravel.
-  Use extreme care and maintain minimum ground speed when transporting on hillside, over rough ground and when operating close to ditches or fences. Be careful when turning sharp corners.
-  Never allow riders on either tractor or implement. Falling off can kill.
-  Be a safe and courteous driver. Always yield to oncoming traffic in all situations, including narrow bridges, intersections, etc.
-  Do not exceed 20 mph (32 kph). Reduce speed on rough roads and surfaces.

## SAFETY INSTRUCTIONS (continued)



### MAINTENANCE SAFETY

-  Good maintenance is your responsibility. Poor maintenance is an invitation to trouble.
  
-  Follow good shop practices.
  - Keep service area clean and dry.
  - Be sure electrical outlets and tools are properly grounded.
  - Use adequate light for the job at hand.
  
-  Make sure there is plenty of ventilation. Never operate the engine of the towing vehicle in a closed building. The exhaust fumes may cause asphyxiation.
  
-  Before working on this machine, drive to a level area, disengage the PTO, lower implement (or if working underneath, raise and block securely), shut off the engine, set the brakes, and remove the ignition keys.
  
-  Be certain all moving parts on attachments have come to a complete stop before attempting to perform maintenance.
  
-  Never work under equipment unless it is blocked securely. Never depend on hydraulic system to keep implement in raised position.
  
-  Keep all persons away from operator control area while performing adjustments, service, or maintenance.
  
-  Always use personal protection devices such as eye, hand and hearing protectors, when performing any service or maintenance.
  
-  Periodically tighten all bolts, nuts and screws and check that all cotter pins are properly installed to ensure unit is in a safe condition.
  
-  When completing a maintenance or service function, make sure all safety shields and devices are installed before placing unit in service.
  
-  Remove hydraulic pressure prior to doing any maintenance. Place the driver ram on the ground or securely blocked up, disengage the PTO, and turn off the engine. Push and pull the remote cylinder lever in and out several times to relieve hydraulic pressure.
  
-  Never use your hands to locate a hydraulic leak on attachments. Use a small piece of cardboard or wood. Hydraulic fluid escaping under pressure can penetrate the skin.
  
-  Openings in the skin and minor cuts are susceptible to infection from hydraulic fluid. If injured by escaping hydraulic fluid, see a doctor at once. Gangrene and death can result. Without immediate medical treatment, serious infection and reactions can occur.

## SAFETY INSTRUCTIONS (continued)



### **MAINTENANCE SAFETY (continued)**



After servicing, be sure all tools, parts and service equipment are removed.



Check to ensure all safety signs are installed and in good condition. (See safety sign section for location drawing.)



Do not allow grease or oil to build up on any deck or platform.



Never replace hex bolts with less than grade five bolts unless otherwise specified, i.e. shear bolts. Refer to bolt torque chart for head identification marking.



Where replacement parts are necessary for periodic maintenance and servicing, genuine factory replacement parts must be used to restore your equipment to original specifications. The manufacturer will not claim responsibility for use of unapproved parts and/or accessories and other damages as a result of their use.



If equipment has been altered in any way from original design, the manufacturer does not accept any liability for injury or warranty.



A fire extinguisher and first aid kit should be kept readily accessible while performing maintenance on this equipment.



### **STORAGE SAFETY**



Following operation, or when unhooking, stop the tractor, set the brakes, lower ram to lowest position and engage transport lock pin, disengage the PTO, shut off the engine and remove the ignition keys.



Store the unit in an area away from human activity.



Do not park equipment where it will be exposed to livestock for long periods of time. Damage and livestock injury could result.



Do not permit children to play on or around the stored unit.



Make sure all parked machines are on a hard, level surface and engage all safety devices.









If blocking is used, make sure it is solid and secure before leaving area.

## SAFETY INSTRUCTIONS (continued)



### **SAFETY TRAINING**

-  Safety is a primary concern in the design and manufacture of our products. Unfortunately, our efforts to provide safe equipment can be wiped out by a single careless act of an operator.
-  In addition to the design and configuration of equipment, hazard control and accident prevention are dependent upon the awareness, concern, prudence and proper training of personnel involved in the operation, transport, maintenance and storage of equipment.
-  It has been said, “The best safety device is an informed, careful operator.” We ask you to be that kind of an operator. It is the operator’s responsibility to read and understand ALL Safety and Operating instructions in the manual and to follow these. Accidents can be avoided.
-  Working with unfamiliar equipment can lead to careless injuries. Read this manual, and the manual for your tractor, before assembly or operating, to acquaint yourself with the machines. It is the post driver owner’s responsibility, if this machine is used by any person other than yourself, is loaned or rented, to make certain that the operator, prior to operating:
1. Reads and understands the operator’s manuals.
  2. Is instructed in safe and proper use.
-  Know your controls and how to stop tractor, engine, and driver quickly in an emergency. Read this manual and the one provided with your tractor.
-  Train all new personnel and review instructions frequently with existing workers. A person who has not read and understood all operating and safety instructions is not qualified to operate the machine. An untrained operator exposes himself and bystanders to possible serious injury or death.
-  Do not allow children to operate this machine.

# SAFETY SIGNS

## CAUTION!

1. Read and follow instruction manual before installing, operating, or performing maintenance on Post Driver.
2. Never place any part of your body under the driving ram when it is in the raised position.
3. Watch out for low overhead electrical wires and limbs when operating the Post Driver.
4. Make sure all helpers are familiar with safety rules. Never let a child or inexperienced person assist.
5. Use extra care when working on slopes. Be sure tractor brakes are set and that Post Driver is aligned vertically before driving a post.
6. Be sure all bystanders are a least 25 ft. away when driving a post.
7. Be sure post is cut "SQUARE" on top. Angle cut posts can "KICK OUT" of Driver and injure the operator.
8. Select only "GOOD, SOLID" posts for driving. Poor quality posts can split or splinter and injure the operator. Always wear gloves and safety glasses when driving a post. Use the special post holder tool provided (**NOT YOUR HAND**) when starting a post.
9. Install transport lock pin and pin clip before transporting or storing the Post Driver. **NEVER INSERT FINGER IN TRANSPORT PIN HOLE TO CHECK ALIGNMENT. Finger could be sheared off if Driving Ram moves.**
10. Always use the special STEEL T-POST Holder when driving steel T-posts (see Figure 1). Order part #814490.

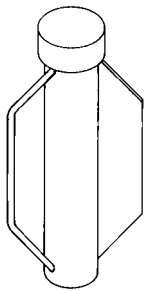

FIG. 1

## WARNING



**AVOID SERIOUS INJURY**

**NEVER PUT HAND OR FINGERS BETWEEN DRIVING RAM AND POST**

FAILURE TO HEED WILL RESULT IN INJURY

101058

## WARNING

**AFTER TRACTOR IS POSITIONED:  
SET BRAKE SECURELY - PUT TRANSMISSION IN PARK**

**WHEN OPERATING:  
NEVER STAND DIRECTLY IN FRONT OF POST DRIVER  
STAND AT A [45°] ANGLE TO THE SIDE.**

**USE SAFETY POST HOLDER ONLY FOR INITIAL PENETRATION.  
WHEN POST IS SELF-STANDING, STEP ASIDE.**

**FAILURE TO HEED THE ABOVE MAY RESULT IN  
PERSONAL INJURY OR DEATH.**

101057

### CAUTION

**ALWAYS WEAR SAFETY GLASSES TO PREVENT EYE INJURY.**

101078

## SAFETY INSTRUCTIONS

1. READ THE OPERATORS MANUAL BEFORE OPERATING THE POST DRIVER.
2. SET BRAKES OR PLACE AUTOMATIC TRANSMISSION IN "PARK" BEFORE DRIVING POSTS.
3. STAND AT A 45° ANGLE TO THE DRIVING RAM. DO NOT STAND IN FRONT OF THE DRIVING RAM. START THE POST WITH A FEW SHORT STROKES UNTIL THE POST IS IN FAR ENOUGH TO HOLD ITS POSITION BY ITSELF, THEN STAND BACK AND FINISH DRIVING THE POST. THE POST DRIVER MUST BE OPERATED BY ONE PERSON ONLY.
4. USE THE SAFETY POST HOLDER TO START POSTS. THEN REMOVE TO FINISH DRIVING POST. NEVER HOLD A POST WITH YOUR HAND.
5. ALWAYS USE STEEL POST SAFETY GUIDE WHEN DRIVING STEEL POSTS.
6. FAILURE TO HEED CAN RESULT IN PERSONAL INJURY OR DEATH.



POST HOLDER

101056

## WARNING



HIGH-PRESSURE FLUID HAZARD

To prevent serious injury or death:

- Relieve pressure on system before repairing or adjusting or disconnecting.
- Wear proper hand and eye protection when searching for leaks. Use wood or cardboard instead of hands.
- Keep all components in good repair.

SW700

# INSTRUCTIONS

---

## TRACTOR REQUIREMENTS AND PREPARATION

---

These instructions are for the Model HPD-16 and HPD-20 Hydraulic Post Drivers.

The Model HPD-16 Post Driver can be used on tractors having either a Category I or II 3 pt. hitch. The Model HPD-16 requires a tractor to have a hydraulic system capable of at least 3-4 gpm and 1500 psi.

The pins may need to be installed to the inside of the 3-point frame for use with Category I tractors.

The larger model, HPD-20 is recommended for use on Category II or larger tractors only. The Model HPD-20 series requires a tractor with a hydraulic system capable of 6-8 gpm and 1500 psi.

The tractor must have front weights to counter-balance the load.



**A heavy load can cause instability in driving a tractor. Make sure the front of the tractor is properly counter-balanced with weights. Always drive slowly – especially around turns. An unstable tractor could steer badly and possibly tip over, causing injury or death.**

It is recommended that the tractor be equipped with a Rollover Protection System (ROPS) and a seat belt that is used.

Be sure your tractor is in good working order, particularly the hydraulic system, prior to using the Post Driver. Be sure the tractor hydraulic oil and filter have been serviced according to the tractor manufacturer's recommendations. The return oil from the driver must be connected directly to the tractor hydraulic fill opening – **NOT TO THE TRACTOR REMOTE OUTLET**. Special return fittings are available, when required, for many popular tractors. Check with your dealer for an application list.

Refer to your tractor owner's manual or dealer to determine if your tractor has an OPEN or CLOSED hydraulic system. The hydraulic valve on the driving ram **MUST** match your tractor hydraulic system. This valve is convertible and is shipped ready for OPEN center systems. See the "maintenance and adjustment" section of this manual for conversion instructions.

Tractor lift arm stabilizer bars, sway chains, or sway blocks must be used to control side movement of the Post Driver. **NOTE:** If your tractor uses top link sensing for the draft control, it will be necessary to lock out the sensing mechanism to minimize front to rear movement of the Post Driver.



**Be sure your tractor is in good condition. Read all the safety precautions and make sure all tractor operators are familiar with the safety rules of operation.**



**BELARUS Tractors require special (additional) hydraulic control valve plumbing. Belarus tractors have a very high relief valve pressure setting and this may cause hydraulic hose failure. OPERATOR SAFETY IS AT RISK. Refer to special instructions on BELARUS Tractor applications on page 14.**

**NOTE:** An optional adjustable leg package is available. Adjustable legs will provide stability to the driver by minimizing movement from rear tractor tire bounce and looseness in hitch linkage. The legs will allow the 3 pt. manual mount driver to be self standing for storage.

## PACKAGING

---

The Post Driver is shipped as four (4) bundles.

1. Driving Ram Assembly
2. Base Plate Assembly
3. 3 Point Mount Assembly
4. Hydraulic package, in a carton.

Please inspect these bundles for any obvious signs of damage before attempting to assemble the Post Driver. Unpack all the bundles and lay out the various parts.

## ASSEMBLY & MOUNTING

---

The following procedure is recommended for assembling the Post Driver.

1. Mount the 3 point hitch assembly to the 3 point of your tractor. Install the low pull pins to the inside for Cat. I applications and outside for Cat. II applications. A  $3/4$ " hole is provided for Cat. I, and a 1" hole for a Cat. II top link. **The top link pin is furnished by the customer.** This hitch will also attach to standard Cat. II quick hitches.  
Quick hitches have some looseness built into them. If the Driver has too much front to rear movement in use, try not using the quick hitch.  
If using the optional adjustable leg package, attach the leg sockets with the legs to each side of the 3 pt. manual mount. Install the adjustment pins from the rear and fasten with the clip pin.
2. Attach the base mounting plate assembly to the 3 point hitch frame using six (6)  $1/2$ " – 13 NC x  $1 1/2$ " hex head bolts, nuts and lock washers.

## INSTRUCTIONS (continued)

- Attach the driving ram assembly to the base plate assembly. A chain hoist or forklift can be used to stand the driving ram assembly upright to its normal working position. Take care not to let the chain damage the hydraulic cylinder when lifting the unit. Once the ram assembly is upright, the tractor can be positioned to align the driving ram assembly to the 3 point hitch and base mounting unit. Align the four (4)  $\frac{5}{8}$ " diameter bolts already in the driving ram assembly with the four (4) holes in the base mount assembly and secure with  $\frac{5}{8}$  - 11 NC nuts and lock washers provided.



### WARNING!

**MAKE SURE THAT ALL OPERATING AND SERVICE PERSONNEL KNOW THAT IN THE EVENT HYDRAULIC FLUID PENETRATES THE SKIN, IT MUST BE SURGICALLY REMOVED WITHIN A FEW HOURS BY A DOCTOR FAMILIAR WITH THIS FORM OF INJURY, OR GANGRENE MAY RESULT.**

- Install the hydraulic package. Refer to Figure A for correct location and orientation of components. Use a good grade hydraulic thread sealant at all thread connections. (Do NOT use Teflon tape sealer.)

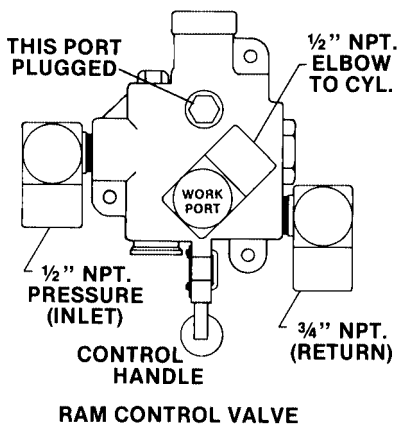

**FIG. A**

Connect the  $\frac{3}{4}$ " I.D. x 24" long hose from the control valve work port to the Post Driver hydraulic cylinder port.

Connect the  $\frac{1}{2}$ " I.D. x 60" long hose from the inlet side of the control valve to one of the tractor hydraulic remote outlets. Connect the  $\frac{3}{4}$ " I.D. x 96" long return line from the control valve directly into the filler opening on the tractor's hydraulic system. On many tractors, the return line can be inserted directly into the filler opening. The hose should be securely tied in place and wrapped with a rag or duct tape to prevent contamination. Special care should be taken to remove the hose when not in use, to prevent rainwater or dirt entering the opening. Screw a  $\frac{3}{4}$ " pipe cap on

the hose end to keep it clean. **Special filler opening adapter fittings are available for most popular tractor models. Contact your dealer for prices and availability.**

**NOTE:** Due to the necessary discharge rate of hydraulic oil, the return line **CANNOT** be connected to the tractor remote outlets. To do so will restrict the drop rate of the driving ram such that it will not properly drive a post.

**NOTE:** Route the hoses to the tractor so that they will not be pinched or caught by the movement of the 3 pt. mount.

- Attach the circular (bulls-eye) level as shown in the parts illustration. Adjust the alignment of the level as follows: using a 2' or longer carpenter's level, adjust the driving ram with the alignment cranks until the ram is plumb front to back and side to side. Tilt the top of the driving ram slightly to the rear to allow for recoil when the ram drops. Now adjust the valve mounting bracket and the handle stop bracket so the level bubble is centered in the level circle (see Figure B), then tighten all bolts.
- Install the valve handle adjustment bolt to limit the upward rate of travel of the driving ram (refer to Figure C). Some tractors with high volume hydraulic pumps will raise the driving ram too fast and can damage the ram carriage if raised to its extreme up position. During normal operation, the ram should be raised only 18" to 24" above the post before dropping the driving ram.

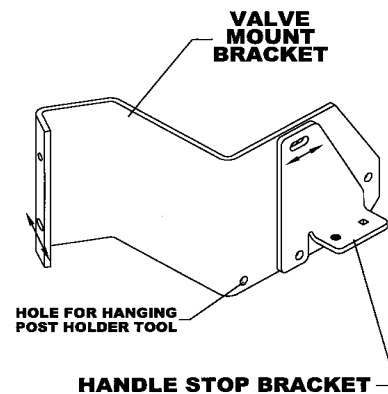

**FIG. B**

- Stand clear of the driving ram assembly and raise the completely assembled unit approximately 10 inches with the 3-point of the tractor. Operate the hydraulic valve on the tractor so that oil flows from the tractor to the valve and returns by the tractor fill opening hose. Tie the tractor hydraulic valve handle into operating position with a tarp strap. The tractor should be operated at an idle until the system is charged with oil. Be sure to check the tractor hydraulic oil level after charging the system.

# INSTRUCTIONS (continued)

## LUBRICATION

- The Post Driver is designed with “special” polyethylene slide blocks for long trouble-free operation.
- Oil or grease applied to the slide channel will make the operation smoother and if applied after use will help keep rust from forming in the channel.
- There are grease fittings on the large slide to side pivot tube and on all the threaded tilt adjustment nuts. A few shots of grease at the beginning of the work day is recommended.
- It is recommended to apply grease or oil to the threaded portion of the tilt adjustment cranks before storage to help prevent rust from forming.
- Smear grease over the exposed portion of the plated hydraulic cylinder rod after use to help prevent pitting and rust from forming. If Post Driver is going to be stored outside this is very important.

## BEFORE YOU START

Review the assembly instructions to be sure the Driver is properly assembled and plumbed correctly for your tractor hydraulic system. The control valve return hose must be connected directly to the tractor hydraulic oil fill opening – NOT to the tractor remote outlets. (**See Assembly Instruction, item #4.**) Refer to the Hydraulic Valve Section (page 11) for open-center and closed-center tractor hydraulic system requirements. Be sure the tractor hydraulic oil and filter have been serviced according to the tractor manufacturer’s recommendations before using the Post Driver.

Tractor lift arm stabilizer bars, sway chains or sway blocks must be used to control side movement of the Post Driver. Also, if your tractor uses top link sensing for the draft control, it will be necessary to lock out the sensing mechanism to control front to rear movement of the Post Driver.

## OPERATION

**Observe all operating and safety instructions in this manual and those on the Post Driver before using this machine.**

1. Position the tractor for driving a post. The 3 pt. hitch of your tractor can be raised or lowered for various post lengths. 3 pt. hitch lift arm stabilizer bars, sway chains or sway blocks must be used to control side movement of the Driver.
2. Set the tractor brakes or place the transmission in “PARK.” Raise the ram slightly and remove the transport pin. Store the pin in the additional top link pin hole.
3. If using the adjustable legs, adjust the legs so that when the driver is at the desired height, the legs will be on the ground supporting the weight of the driver.

4. Align the driving ram vertically by use of the “bulls-eye” bubble level and the two (2) alignment cranks.
5. Raise the driving ram by lifting up on the control valve handle. **NOTE: Do not allow the ram to continually hit the urethane bumpers at the top of the carriage. Tractors with high volume hydraulic pumps will cause the ram to raise very fast.** If the ram raises too fast, adjust the limiting screw to limit the amount of handle movement (see Figure C). Raise the ram so that it is 18” to 24” above the top of the post. The tractor hydraulic control valve should be tied in the “ON” position so the Driver is controlled solely by the Post Driver control valve.

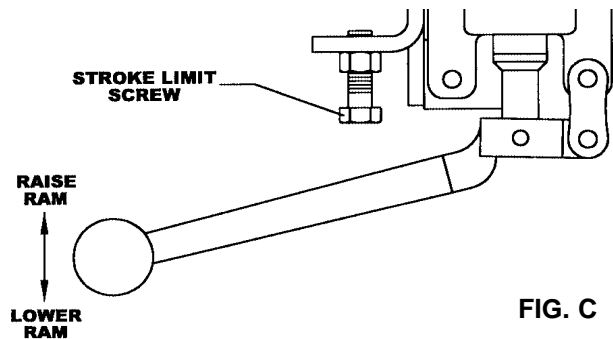

FIG. C

6. Place the post within the driving ram. The back of the post should be against the web of the I-Beam and centered between the flanges. Stabilize the post using the special “Post Holder Tool” provided.



**NEVER hold the post with your hand. Always use the special STEEL T-POST Holder when driving steel T-posts. Order part #814490.**

7. Stand at a 45° angle to the post – not directly in front of the post. Be sure all bystanders are at a safe distance from the Post Driver.
8. Drop the driving ram by pushing “Full Down” on the control valve handle.
9. Repeat raising and dropping the driving ram until the post is to the desired depth. Be sure the ram slide blocks are not “BOTTOMING OUT” on the urethane bumpers. Likewise, do not raise the ram to its extreme up position with each stroke. The ram should normally be raised 18” to 24” above the top of the post. Once the post is deep enough to be stable, it is no longer necessary to hold the post with the “POST HOLDER TOOL.” Stand back and “DRIVE” the post.
10. In dry or light rocky conditions, cutting a point on the post may be beneficial. The point should be centered on the post to prevent the post veering to one side.
11. Re-engage the transport lock pin when finished with the job.

# INSTRUCTIONS (continued)

## BELARUS TRACTORS - Special Hydraulic Plumbing INSTRUCTIONS:

BELARUS Tractors require special (additional) hydraulic control valve plumbing. BELARUS Tractors have a very high relief valve pressure setting and this may cause hydraulic hose failure. **OPERATOR SAFETY IS AT RISK.**

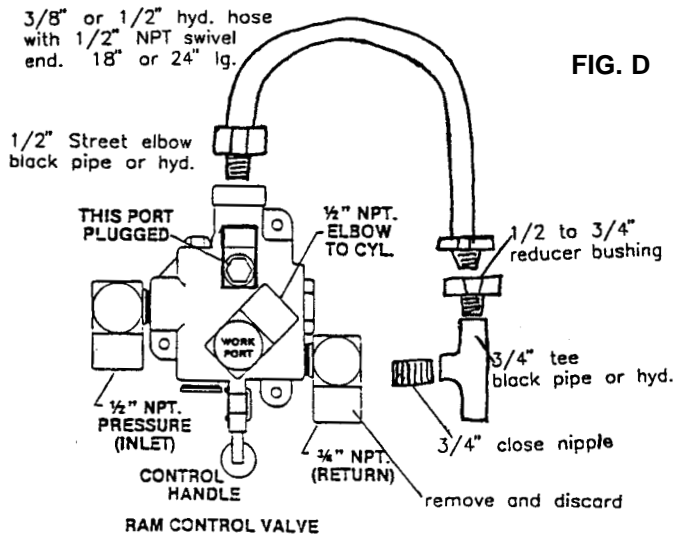

FIG. D

1. Remove the pipe plug from the upper valve work port and replace with a 1/2" 90° street elbow. Position the 1/2" elbow so opening is up.
2. Remove the 3/4" NPT 90° return elbow replace it with a 3/4" close nipple, 3/4" tee, and a reducer bushing as shown.
3. Interconnect an 18" or 24" hydraulic hose assembly (SAE 100R1 rating) to the 1/2" elbow and 3/4" tee as shown. The hose assembly must have at least one swivel end fitting.
4. Connect the 3/4" I.D. x 96" long return line hose to the other end of the 3/4" tee.
5. Use a hydraulic type thread compound on all connections.

**DO NOT USE TEFLON TAPE.**

## MAINTENANCE AND ADJUSTMENTS

Make certain the safety and instruction decals are attached to the Post Driver. If they are lost, damaged, or painted over, order replacements.



**Before servicing the machine, engage the parking brake or place the transmission in "Park," shut off the tractor and remove the key. Relieve all hydraulic pressure in lines.**

## HYDRAULIC VALVE

The hydraulic control valve supplied with the Post Driver is "convertible" to accommodate both open-center and closed-center tractor hydraulic systems. Most John Deere and some other late model tractors use closed-center hydraulic systems. Consult your tractor owner's manual (specifications section) or your tractor dealer. The control valve is shipped "ready" for open-center hydraulic systems.

**NOTE: Failure to make the control valve compatible with your tractor hydraulic system will cause the hydraulic oil to overheat.**

## VALVE CONVERSION INSTRUCTIONS

The conversion plug for making the control valve compatible with closed-center hydraulic systems is shipped in the hardware box (see Figure E).

Remove the large hex open-center plug and store it in a safe place. Install the optional closed-center plug from the hardware box. Be sure the O-ring and seal are on the plug before insertion. **DO NOT** use a thread sealant on the conversion plug.

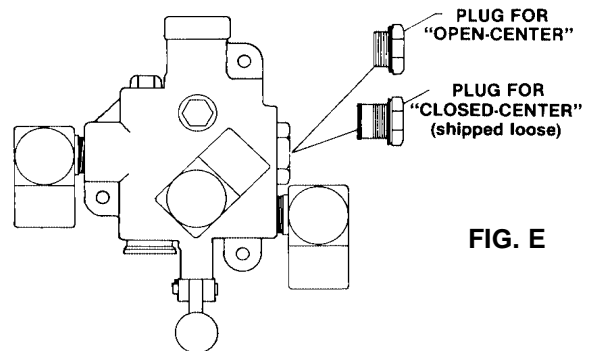

FIG. E

## HYDRAULIC CYLINDER BASE AND ROD END ADJUSTMENT

Due to the design of the Driver carriage, it is necessary for both the base and rod end of the hydraulic cylinder to have a slight amount of freedom. This adjustment should only be necessary if the hydraulic cylinder is removed for servicing (see Figure F).

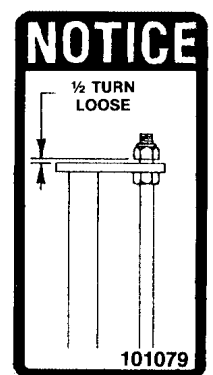
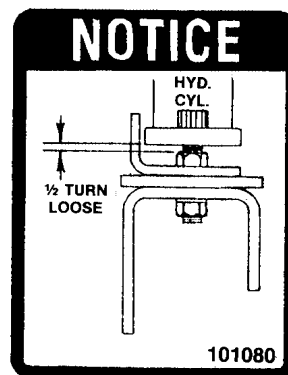

FIG. F

# INSTRUCTIONS (continued)

## DISASSEMBLY – CARRIAGE AND RAM ASSEMBLY

1. Lay the driving ram assembly face down on the floor or on a solid workbench.
2. Remove the transport lock pin. This will allow the ram carriage to move up, thereby relieving the spring tension. Disconnect the upper spring bracket.
3. Remove the lock nut from the top of the cylinder rod and push the rod back into the cylinder.
4. Now remove the hex nuts holding the transport lock pin bracket in place. Slide the carriage down and remove the hydraulic cylinder and springs as a unit from the lower end.
5. The carriage can now be removed from the upper end of the ram assembly.

## HYDRAULIC CYLINDER DISASSEMBLY

1. Remove the hydraulic cylinder from the carriage.
2. Place the base end of the hydraulic cylinder in a vise, support the upper end of the cylinder and unscrew the aluminum cap. **DO NOT** remove the cap over the upper threaded end of the cylinder rod.
3. Pull the rod from the cylinder tube.
4. Remove the nut from the lower end of the cylinder rod. The rod should be protected with leather, cardboard or wood blocks and placed in a vise to remove the nut. Remove the aluminum rod guide. Now slide the cap down the cylinder rod and remove it from the bottom (unthreaded) end.
5. **NOTE:** It is advisable to install a new rod guide, cylinder cap and seal as a unit when rebuilding the cylinder. Also inspect the cylinder rod for pits and/or rust and replace if necessary.

## CAP SEAL REPLACEMENT

1. Use a screwdriver or knife to remove the old seal. Soften the new seal by placing it in warm water or direct light from a lamp. Squeeze the new seal together and place one end of it in the seal groove. Force down on the other end of the seal, and it will snap into place. Inspect the seal to be sure it is properly seated (see Figure G).

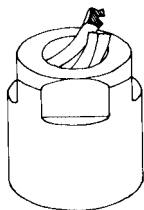

FIG. G

2. Oil the new seal and slide the cap onto the cylinder rod from the bottom end. Do not slide the cap on over the upper threaded end of the rod. This will damage the seal.
3. Replace the rod guide and retaining nut. Be sure to protect the rod with leather, cardboard, etc., when holding the rod in a vise for tightening the nut. **DO NOT** hold the rod with a pipe wrench.
4. Insert the rod assembly in the cylinder tube. Place the base end of the cylinder in a vise and support the upper end. **DO NOT** tighten the vise on the cylinder tube, as this may collapse the tubing. Use a good grade hydraulic thread sealer and tighten the aluminum cap.

## SPRING REPLACEMENT

1. Lower the driving ram so the springs are in their relaxed position. Remove the upper spring bracket from the square tube by removing the  $\frac{3}{8}$ " bolt holding it in place.
2. Remove the upper spring clip from the spring bracket by rotating the clip and sliding it out the keyhole slot in the bracket.
3. Insert a screwdriver in the spring clip and screw it out of the spring coils. The spring can be removed from the lower spring clip by rotating the spring.
4. Install new spring clips by inserting a screwdriver in the end coil and screwing the clip onto the first two coils (see Figure H). Use a large pair of adjustable (water pump) pliers and close the ends of the spring clips to retain them on the spring.
5. To replace the springs, it is necessary to remove the top spring anchor (#814408) and to remove the two lower bolts that hold the lower end of the main hydraulic cylinder. Removing these bolts will allow the removal of the lower spring bracket (#814430 on HPD-16 and #814527 on HPD-20).

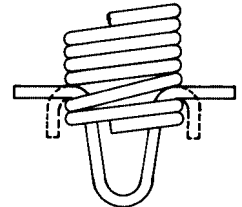

FIG. H

**NOTE:** The lower hydraulic cylinder mounting bolts have stamploc hex nuts ( $\frac{3}{8}$ " on HPD-16 and  $\frac{1}{2}$ " on HPD-20). **DO NOT** use regular hex nuts in place of these nuts. They need to be stamploc nuts. Also, on reassembly, there are instructions on the proper adjustment of these bolts. See the section on Hydraulic Cylinder Base and Rod End Adjustment. (Figure F).

## INSTRUCTIONS (continued)

### STORING THE POST DRIVER

Lower the ram to the lowest position and engage the transport lock pin. This position will have the hydraulic cylinder rod fully retracted into the cylinder and will be self-protecting.

Smear grease over the exposed portion of the plated hydraulic cylinder rod to prevent pitting and rust from forming.

It is recommended to apply grease or oil to the threaded portion of the tilt adjustment cranks to help prevent rust from forming.

Be sure to cap the open return line hose end to prevent contamination during storage. Lubricate all grease fittings prior to storage.

Inside storage is preferred to prevent deterioration of the springs, hoses, etc. For safety, the Driver should be securely blocked and chained to a post or wall for stability. An alternative is to hang the Driver on a post driven into the ground. Be sure to chain the Post Driver to the post for safety.

**NOTE:** If using the adjustable legs, locate the transport locking pin into the higher hole location in the ram and then adjust legs to same height.

Turn front to rear adjustment crank to widen the distance of the legs to the bottom of the ram. Make sure driver will be located on a solid surface and in a location away from children, animals, or traffic area.

## POST DRIVER SPECIFICATIONS

	HPD-16	HPD-20
Maximum post size . . . . .	7" x 9'	8 <sup>3</sup> / <sub>4</sub> " x 10'
Impact at full stroke . . . . .	32,000 lb.	80,000 lb.
Impact at half stroke . . . . .	16,000 lb.	40,000 lb.
Minimum tractor size . . . . .	20-22 hp*	50-60 hp
Rear hitch type . . . . .	Cat. I or II	
Minimum hydraulics required . . . .	3 - 4 gpm	6 - 8 gpm
Drive cylinder size . . . . .	2" x 56"	2" x 68"
Operating range (above ground) . .	50" to 116"	50" to 128"
Tilt adjustment – front/back . . . . .	20° + (10° from vertical plus top link adjustment)	
Tilt adjustment – side/side . . . . .	34° (17° from vertical – each way)	
Shipping weight . . . . .	456 lb.	633 lb.

\* Front weights required on small tractors

# TROUBLE – SHOOTING

---

## **PROBLEM: DRIVER DOES NOT DRIVE A POST**

### **SOLUTIONS:**

1. The hydraulic valve return line is connected to a tractor remote outlet and/or a quick coupler is being used. Connect the return line directly to the tractor reservoir filler opening.
2. The ram may be binding in the carriage or carriage slide blocks may need lubrication or replacement.
3. Carriage springs may be disconnected or broken.
4. Ground may be too dry or hard. Pointing the post may help. Otherwise, wait for rain.
5. Post may be encountering a rock. Relocate post 6-8 inches and try again. Pointing post may help in light, rocky soil.
6. Remote hydraulic connection fittings not compatible. Check for proper fitting.

## **PROBLEM: DRIVING RAM WILL NOT RAISE, OR RAISES SLOWLY**

### **SOLUTIONS:**

1. Hydraulic valve may be improperly plumbed. See assembly instructions.
2. Post Driver control valve handle “UP” limit screw may need adjustment (see Figure C page 13).
3. Carriage may be binding. Check for broken springs, worn slide blocks or other obstructions.
4. Hydraulic cylinder rod guide (piston) may be excessively worn.
5. Tractor hydraulic system may not be supplying rated pressure (usually 1500 to 2250 PSI). Consult your tractor dealer.
6. Tractor hydraulic system may not be delivering its rated volume of oil due to wear. Hydraulic pump may need to be repaired.
7. Hydraulic valve on Post Driver is not compatible with tractor hydraulic system. See Hydraulic Valve section in this manual.
8. Hydraulic valve on Post Driver may be leaking and need to be repaired or replaced.
9. Carriage may be bent due to hitting overhead object. Straighten or replace carriage assembly.

## **PROBLEM: POST VEERS OFF AT AN ANGLE WHILE BEING DRIVEN**

### **SOLUTIONS:**

1. Top of post is not cut “square,” causing the post to drive at an angle. Re-cut top of post “square.”
2. Bottom of post is cut at an angle or post is pointed off-center.
3. Tractor 3 pt. may be moving sideways. Install lift arm stabilizer bars, sway chains or sway blocks to limit lift arm movement.
4. Tractor may have “Top Link Load Sensing” upper link (usually Ford/New Holland and M-F). Install pin to “lock out” sensing mechanism movement.
5. Tractor has moved slightly while driving post. Always set brakes and use extra care on slopes.
6. Adjustable legs on 3 pt. mount are not setting firmly on the ground. Re-adjust legs.
7. Ground may be too dry or hard. Pointing the post may help. You may have to wait until it rains if ground is extremely hard and dry.
8. Post may be encountering a rock. Relocate post 6-8 inches and try again. Pointing post may help in light, rocky soil.
9. Driver ram may be improperly angled – if top of ram is angled away from post, ram will veer off post. Re-adjust ram angle.
10. Tractor may not be large enough to handle driver. Use larger heavier tractor. NOTE: Adjustable legs will allow the use of smaller size tractors.
11. Using a Quick-Hitch – May have to remove Quick-Hitch and connect directly to 3 pt. arms.

## **PROBLEM: DRIVER RAM RAISES VERY FAST AND HITS TOP URETHANE BUMPERS**

### **SOLUTIONS:**

1. Post Driver control valve “UP” limit screw needs adjusting.
2. Tractor model has high volume hydraulic oil pump. Set tractor throttle at lower speed to reduce volume of oil or if necessary, install an orifice in line to reduce volume of oil.

## TROUBLE – SHOOTING (continued)

### **PROBLEM: DRIVER HAS EXCESSIVE MOVEMENT OR BOUNCE**

#### SOLUTIONS:

1. Top of post is not cut “square,” causing the driver to veer off at an angle. Re-cut top of post “square.”
2. Tractor 3 pt. may be moving sideways. Install lift arm stabilizer bars, sway chains or sway blocks to limit lift arm movement.
3. Tractor may have “Top Link Load Sensing” upper link (usually Ford/New Holland and M-F). Install pin to “lock out” sensing mechanism movement.
4. Adjustable legs on 3 pt. mount are not setting firmly on the ground. Re-adjust legs.
5. Carriage springs may be disconnected or broken.
6. Ground may be too dry or hard. Pointing the post may help. You may have to wait until it rains if ground is extremely hard and dry.
7. Post may be encountering a rock. Relocate post 6-8 inches and try again. Pointing post may help in light, rocky soil.
8. Driver ram may be improperly angled – if top of ram is angled away from post, ram will veer off post. Re-adjust ram angle.
9. Tractor may not be large enough to handle driver. Use larger heavier tractor.
10. Using a Quick-Hitch – May have to remove Quick-Hitch and connect directly to 3 pt. arms.

### **PROBLEM: OIL SQUIRTS OUT OF RETURN LINE ORIFICE IN TRACTOR**

#### SOLUTIONS:

1. Wrong return line fitting being used.
2. Return line not properly secured with wire or tarp strap.
3. Wrong tractor return line opening is being used. Check tractor for alternate return opening.

### **PROBLEM: HYDRAULIC HOSE FAILURE**

#### SOLUTIONS:

1. Tractor hydraulic relief pressure setting is very high and may cause hydraulic hose failure. Requires plumbing other work port of post driver control valve to return line. (See special instructions for Belarus Tractors.)
2. Hoses are worn or frayed – replace hose.
3. Hose rating may be too low for hydraulic system pressure. Replace with higher rated hoses.
4. Hose is being pinched by movement of 3 pt. mount or 3 pt. linkage.

### **PROBLEM: HYDRAULIC OIL OVERHEATS**

#### SOLUTIONS:

1. Hydraulic oil level in tractor may be low.
2. Hydraulic oil or oil filter in tractor may be dirty. Change oil and filter according to tractor manufacturer’s recommendations.
3. Hydraulic oil reservoir of tractor may be small. Allow time for oil to cool down.
4. Hydraulic valve on Post Driver may not be compatible with tractor hydraulic system. See Hydraulic Valve section in this manual.

# HPD-16 PARTS DRAWING

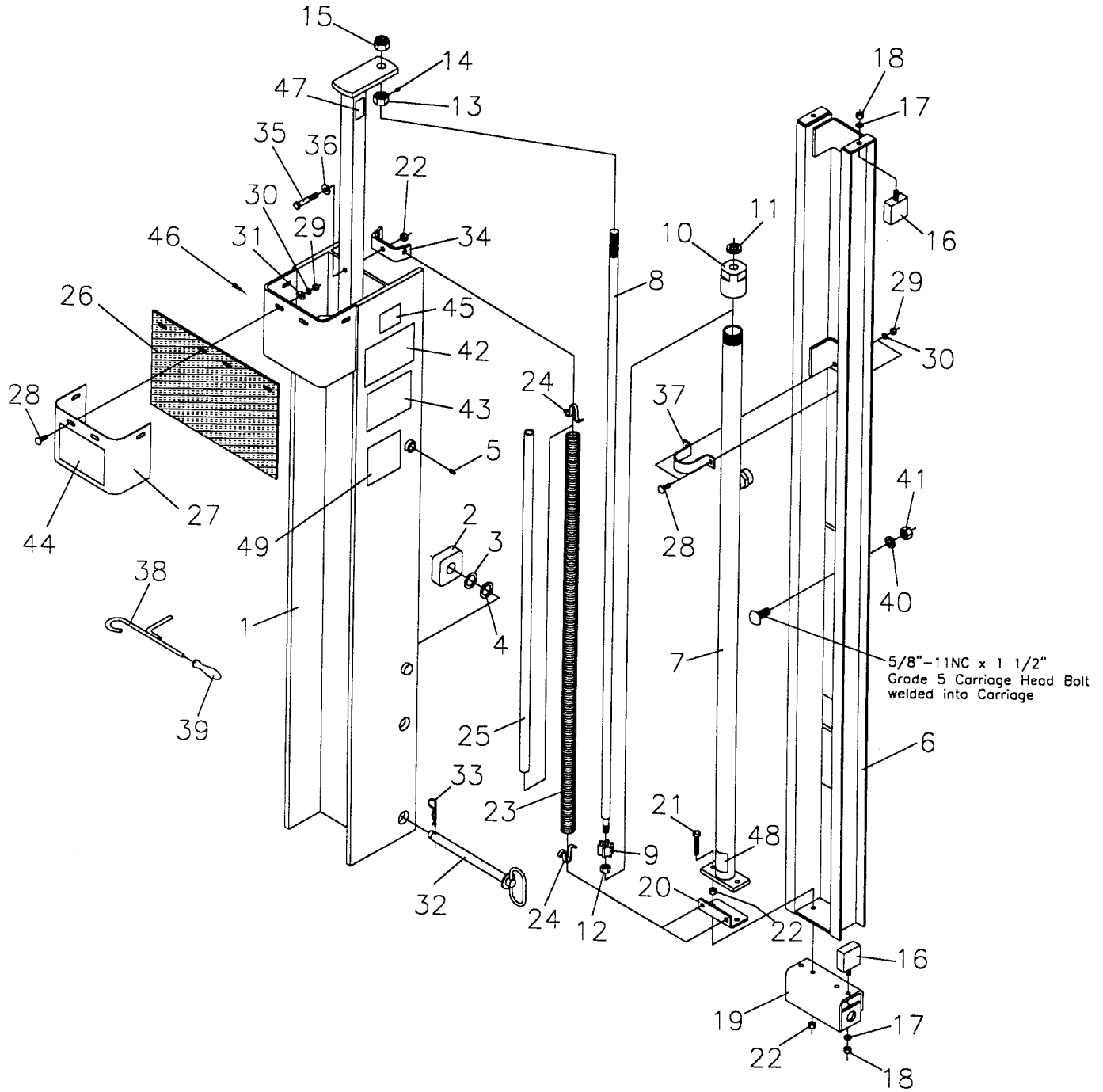

## HPD-16 PARTS LIST

Ref. No.	Part No.	Description	No. Req'd.
1	814401	Driving Ram Weldment	1
2	814551	Guide Block	4
3	2504132	Machinery Bushing 1"ID x 18 Ga.	Var.
4	2504110	Machinery Bushing 1"ID x 14 Ga.	Var.
5	2504049	Drive Zerk 5/16"	2
6	814411	Carriage Weldment	1
	814478	Complete Cylinder Assembly (Items #7 thru #15)	1
7	814417	Tube, Hydraulic Cylinder	1
8	814421	Rod, Hydraulic Cylinder	1
9	814422	Rod Guide, Hydraulic Cylinder	1
10	814495	End Cap w/Rod Seal	1
11	814424	Rod Seal (only)	1
12	2500054	Nut 1/2"-13NC Stamplock Hex	1
13	814425	Nut 3/4"-10NC Full Hex (Drilled & Tapped)	1
14	2503196	Set Screw 1/4"-20NC x 1/4"	1
15	2500037	Nut 3/4"-10NC Nylock Hex	1
16	814426	Bumper, Urethane	4
17	2502008	Washer 3/8" Springlock	4
18	2500004	Nut 3/8"-16NC Full Hex	4
19	814427	Transport Lock Weldment	1
20	814430	Lower Spring Bracket	1
21	2503198	Bolt 3/8"-16NC x 2" Gr. 8 Full Thread	2
22	2500055	Nut 3/8"-16NC Stamplock Hex	5
23	814431	Spring, Driving Ram	2
24	814432	Clip, Spring	4
25	814581	Pipe, Plastic Stabilizing	2
26	814433	Rubber Guard	1
27	814629	Guard Retainer	1
28	2503110	Bolt 5/16"-18NC x 1" Carriage Head	6
29	2500011	Nut 5/16"-18NC Full Hex	6
30	2502011	Washer 5/16" Springlock	6
31	2501012	Washer 5/16" Flat	4
32	814488	Pin, Transport Lock	1
33	590188	Hair Clip Pin 5/32" (AK-2705)	1
34	814408	Upper Spring Bracket	1
35	2503201	Bolt 3/8"-16NC x 2 1/4" Gr. 5 Hex Head	1
36	2501004	Washer 3/8" Flat	1
37	814543	Cylinder Stabilizer Strap	1
38	814476	Post Holder w/Handle	1
39	2504129	Handle, Post Holder	1
40	2502007	Washer 5/8" Springlock	6
41	2500013	Nut 5/8"-11NC Full Hex	6
42	101056	Safety Sign - Safety Instructions	1
43	101057	Safety Sign - Warning (Set Brake)	1
44	101058	Safety Sign - Warning (Avoid Injury)	1
45	101078	Safety Sign - Caution (Safety Glasses)	1
46	101027	Safety Sign - Warning (Stand Clear)	1
47	101079	Safety Sign - Notice (1/2 Turn Loose)	1
48	101080	Safety Sign - Notice (1/2 Turn Loose)	1
49	101122	Safety Sign - Warning (Hi-Pressure)	1

# HPD-20 PARTS DRAWING

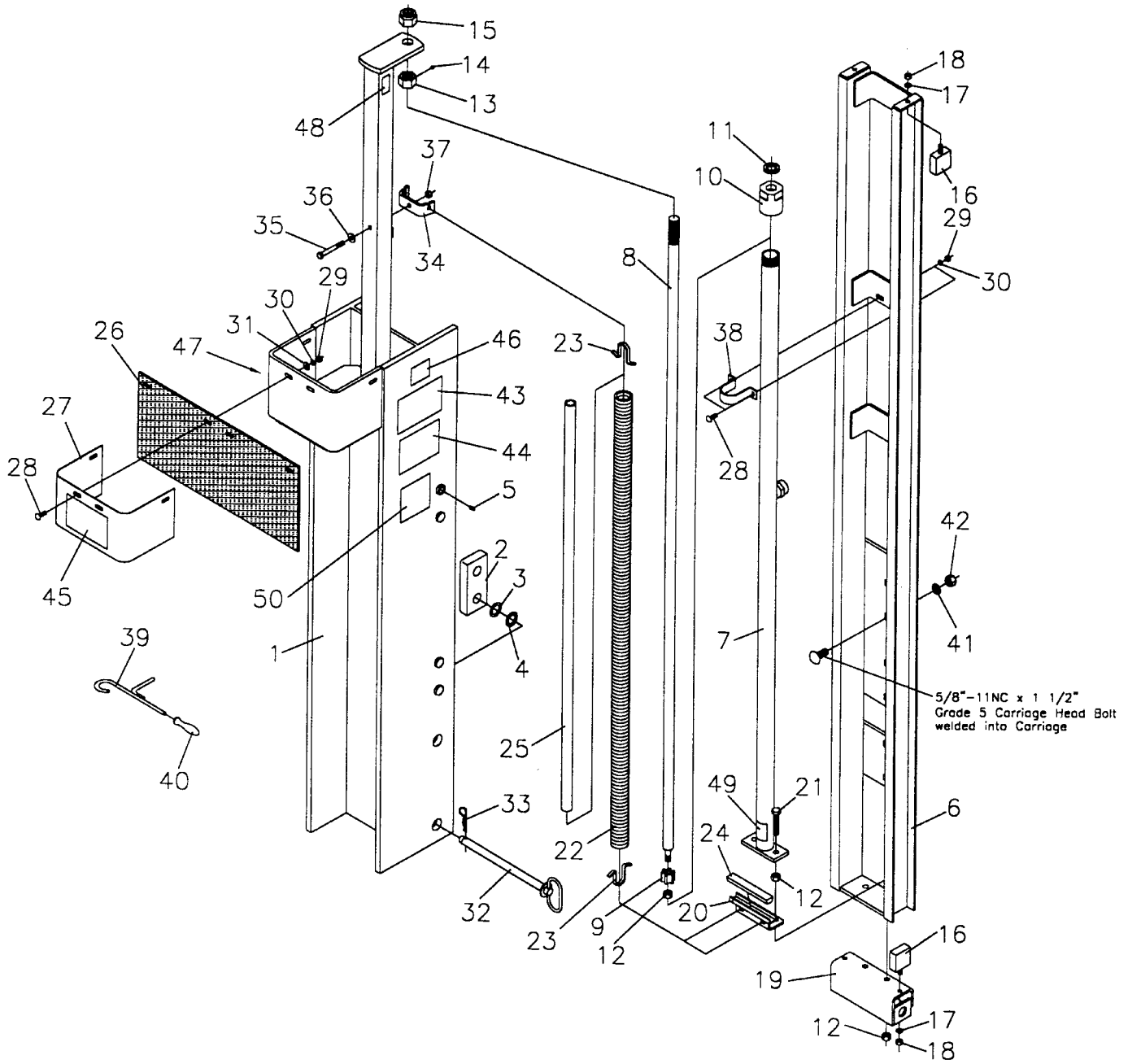

## HPD-20 PARTS LIST

Ref. No.	Part No.	Description	No. Req'd.
1	814502	Driving Ram Weldment	1
2	814549	Guide Block	4
3	2504132	Machinery Bushing 1"ID x 18 Ga.	Var.
4	2504110	Machinery Bushing 1"ID x 14 Ga.	Var.
5	2504049	Drive Zerk 5/16"	2
6	814510	Carriage Weldment	1
	814516	Complete Cylinder Assembly (Items #7 thru #15)	1
7	814517	Tube, Hydraulic Cylinder	1
8	814520	Rod, Hydraulic Cylinder	1
9	814422	Rod Guide, Hydraulic Cylinder	1
10	814538	End Cap w/Rod Seal	1
11	814523	Rod Seal (only)	1
12	2500054	Nut 1/2"-13NC Stamplock Hex	5
13	814524	Nut 1"-14NF Full Hex (Drilled & Tapped)	1
14	2503196	Set Screw 1/4"-20NC x 1/4"	1
15	2500057	Nut 1"-14NF Nylock Hex	1
16	814426	Bumper, Urethane	4
17	2502008	Washer 3/8" Springlock	4
18	2500004	Nut 3/8"-16NC Full Hex	4
19	814525	Transport Lock Weldment	1
20	814527	Lower Spring Bracket	1
21	2503202	Bolt 1/2"-13NC x 2 1/2" Gr. 8 Full Thread	2
22	814530	Spring, Driving Ram	2
23	814531	Clip, Spring	4
24	814532	Damper, Spring	1
25	814547	Pipe, Plastic Stabilizing	2
26	814533	Rubber Guard	1
27	814626	Guard Retainer	1
28	2503110	Bolt 5/16"-18NC x 1" Carriage Head	6
29	2500011	Nut 5/16"-18NC Full Hex	6
30	2502011	Washer 5/16" Springlock	6
31	2501012	Washer 5/16" Flat	4
32	814536	Pin, Transport Lock	1
33	590188	Hair Clip Pin 5/32" (AK-2705)	1
34	814408	Upper Spring Bracket	1
35	2503072	Bolt 3/8"-16NC x 3" Gr. 5 Hex Head	1
36	2501004	Washer 3/8" Flat	1
37	2500055	Nut 3/8"-16NC Hex Stamplock	1
38	814543	Cylinder Stabilizer Strap	1
39	814476	Post Holder w/Handle	1
40	2504129	Handle, Post Holder	1
41	2502007	Washer 5/8" Springlock	6
42	2500013	Nut 5/8"-11NC Full Hex	6
43	101056	Safety Sign - Safety Instructions	1
44	101057	Safety Sign - Warning (Set Brake)	1
45	101058	Safety Sign - Warning (Avoid Injury)	1
46	101078	Safety Sign - Caution (Safety Glasses)	1
47	101027	Safety Sign - Warning (Stand Clear)	1
48	101079	Safety Sign - Notice (1/2 Turn Loose)	1
49	101080	Safety Sign - Notice (1/2 Turn Loose)	1
50	101122	Safety Sign - Warning (Hi-Pressure)	1

HYDRAULIC CONTROL VALVE  
AND MOUNTING BRACKET  
PARTS DRAWING

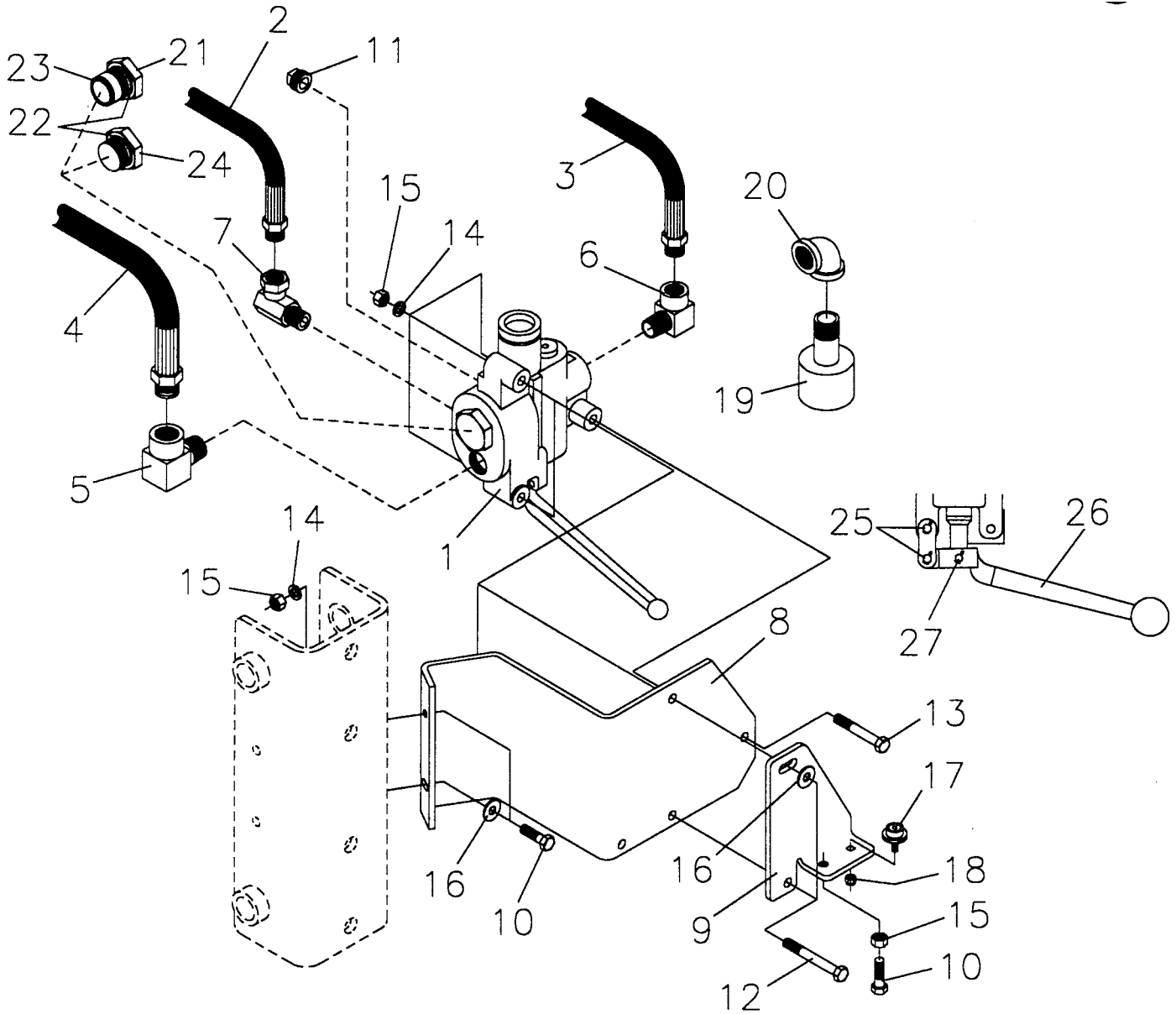

HYDRAULIC CONTROL VALVE  
AND MOUNTING BRACKET  
PARTS LIST

Ref. No.	Part No.	Description	No. Req'd.
1	814473	Valve, Hydraulic	1
2	2504125	Hose, Cylinder 3/4" ID x 24" Double Braid	1
3	2504126	Hose, Pressure 1/2" ID x 60" Double Braid	1
4	2504131	Hose, Return 1" ID x 96" Single Braid	1
5	2504128	Elbow, Street 3/4" NPT 90°	1
6	2505503	Elbow, Street 3/4" to 1/2" NPT 90°	1
7	2504180	Elbow, 90° Swivel 1/2" NPT	1
8	814474	Bracket, Valve Mount	1
9	814475	Stop, Valve Handle	1
10	2503020	Bolt 3/8"-16NC x 1 1/4" Hex Head	3
11	2504133	Pipe Plug 1/2" NPT Socket Head	1
12	2503072	Bolt 3/8"-16NC x 3" Gr. 5 Hex Head	2
13	2503205	Bolt 3/8"-16NC x 2 1/2" Gr. 5 Hex Head	1
14	2502008	Washer 3/8" Springlock	5
15	2500004	Nut 3/8"-16NC Full Hex	6
16	2501004	Washer 3/8" Flat	2
17	814489	Level Assembly	1
18	2500006	Nut 1/4"-20NC Nylock Hex	1
19	814496	Return Adapter	1
20	2504139	Elbow 3/4" NPT 90° Black	1
21	2504135	Closed Center Plug Kit (includes #22 & #23)	1
22	2504136	Seal, Hydraulic Valve Plug	1
23	2504137	Seal, Quad	1
24	2504138	Open Center Plug Kit (includes #22)	1
25	814541	Handle Link Assembly (Side Plate, Link Pin, & Cotter Pins)	1
26	814593	Handle, Valve	1
27	814589	Pin, Handle (Pin & Cotter Pin)	1
NS	814552	Spring to Center Kit (Valve)	1
NS	814594	Rubber Bonnet, Valve	1

ADJUSTABLE MANUAL BASE  
MOUNTING PACKAGE  
PARTS DRAWING AND LIST

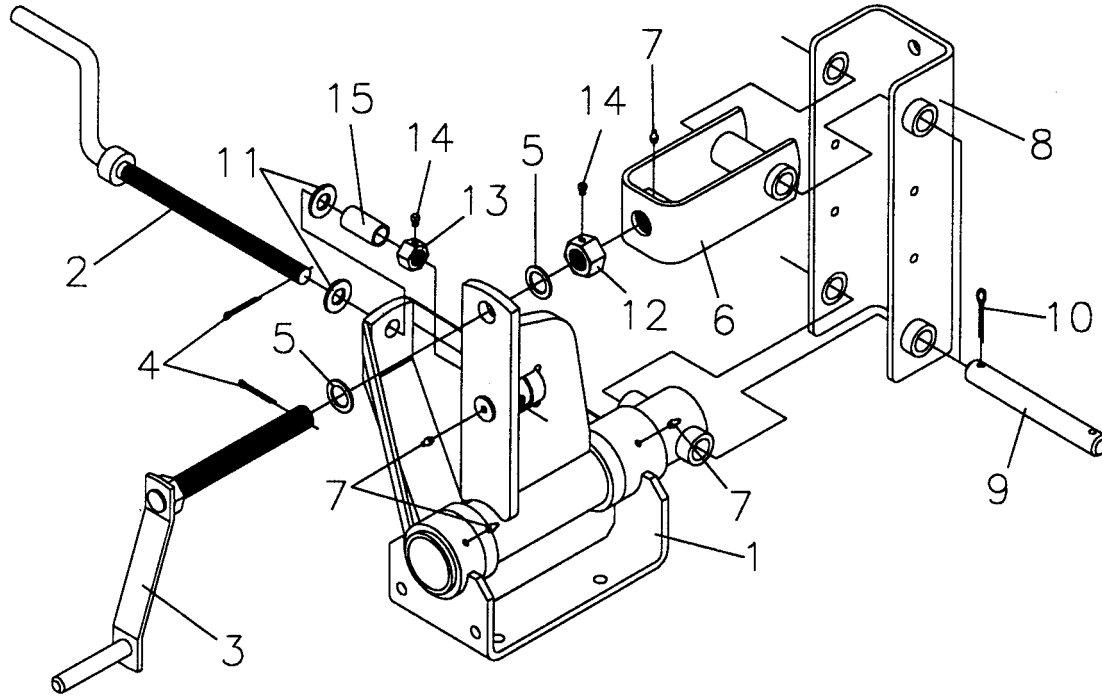

Ref. No.	Part No.	Description	No. Req'd.
1	814438	Manual Pivot Weldment	1
2	814450	Side Tilt Crank (3/4"-10NC Threads)	1
3	814453	Fore & Aft Crank (1"-8NC Threads)	1
4	2504015	Cotter Pin 1/8" x 1 1/2"	2
5	2504110	Machinery Bushing 1" ID x 14 Ga.	2
6	814457	Clevis Weldment	1
7	2504049	Drive Zerk 5/16"	4
8	814460	Support Channel Weldment	1
9	830309	Lift Pin 1" Dia. x 8" Lg.	2
10	2504068	Cotter Pin 1/4" x 1 3/4"	4
11	2504149	Machinery Bushing 3/4" ID x 10 Ga.	2
12	814463	Nut 1"-8NC Full Hex (Drilled & Tapped)	1
13	814425	Nut 3/4"-10NC Full Hex (Drilled & Tapped)	1
14	2503196	Set Screw 1/4"-20NC x 1/4"	2
15	590027	Toplink Bushing (AK-54)	1

OPTIONAL ADJUSTABLE  
LEG PACKAGE  
PARTS DRAWING  
AND LIST

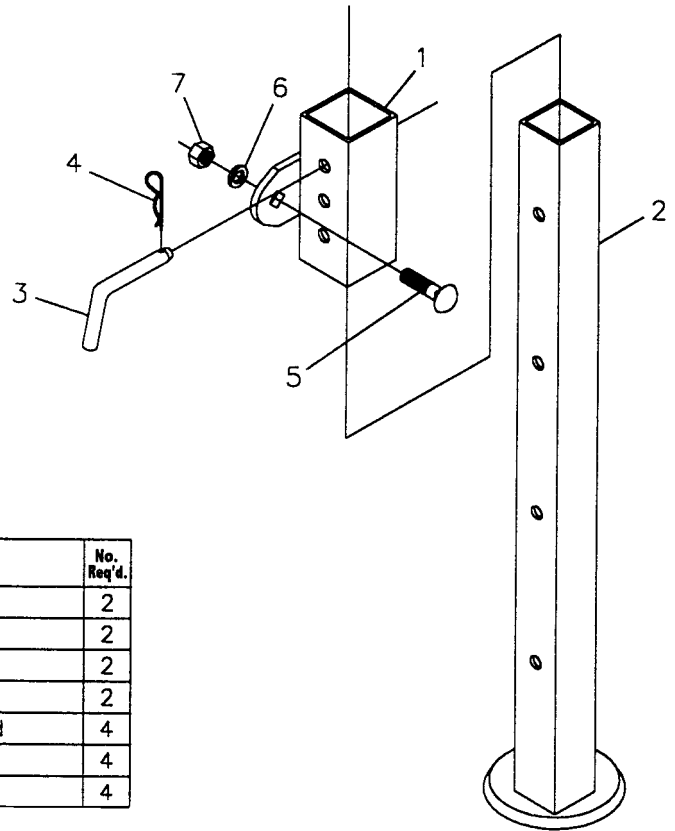

Ref. No.	Part No.	Description	No. Req'd.
1	814586	Stand Tube Mount Weldment	2
2	814687	Stand Tube Weldment	2
3	803637	Stand Pin	2
4	590187	Hair Clip Pin (AK-2704)	2
5	2503136	Bolt 5/8"-11NC x 2" Gr. 5 Carriage Head	4
6	2502007	Washer 5/8" Springlock	4
7	2500013	Nut 5/8"-11NC Full Hex	4

3 PT. HITCH  
PARTS DRAWING  
AND LIST

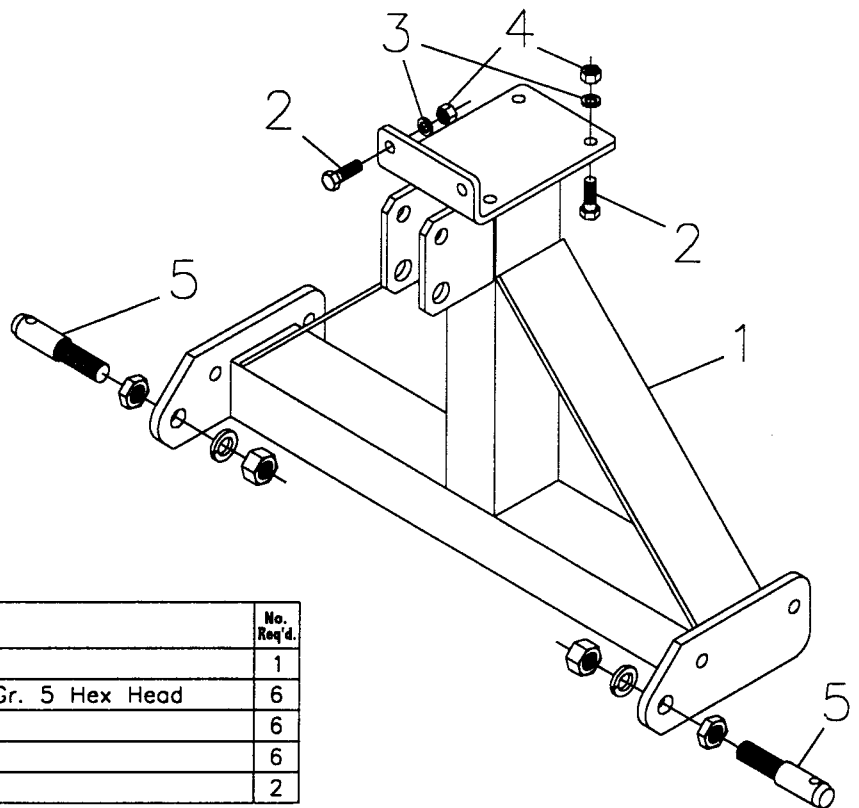

Ref. No.	Part No.	Description	No. Req'd.
1	814465	3 Pt. Hitch Mount Weldment	1
2	2503145	Bolt 1/2"-13NC x 1 1/2" Gr. 5 Hex Head	6
3	2502002	Washer 1/2" Springlock	6
4	2500003	Nut 1/2"-13NC Full Hex	6
5	590078	Draw Pin (AK-2118)	2

# ⚠ SAFETY PRECAUTIONS ⚠

**MOST ACCIDENTS OCCUR BECAUSE OF NEGLIGENCE OR CARELESSNESS.  
AVOID NEEDLESS ACCIDENTS BY FOLLOWING ALL OF THE SAFETY PRECAUTIONS LISTED BELOW.**

- Machinery should be operated only by those who are responsible and are authorized to do so.
- Stop the engine, lower all equipment, lock the brakes, and remove the ignition key before dismounting from the tractor.
- Never stand between tractor and implement while tractor is being backed to hitch.
- Loose fitting clothing should not be worn, to avoid catching on various parts.
- Detach implement in area where children normally do not play.
- When performing adjustments or maintenance on an implement, first lower it to the ground or block it securely at a workable height.
- Only a qualified operator should be permitted on tractor when in operation; no riders allowed.
- Make certain everyone is in the clear before starting tractor or raising or lowering equipment.
- Operate the tractor and implement only while seated in the driver's seat.
- Reduce speed when transporting mounted implements to avoid bouncing and momentary loss of steering control.
- A heavy load can cause instability of the tractor. Use extreme care during road travel. Slow down on turns and watch out for bumps. Tractor may need front counterweights to counter-balance the weight of the implement.
- Reduce speed on hillsides or curves so there is no danger of tipping.
- Avoid driving too close to the edge of ditches or creeks.
- Do not transport implement on public roads without reflectors and slow moving vehicle emblem in daylight and with approved warning lights at night and other periods of poor visibility.
- Due to the width of some implements, use extra caution on highways, farm roads, and when approaching gates.
- Always be sure the implement is in the proper position for transport.
- Keep alert and watch the front as well as the rear when working with the implement.

## OWNER'S MANUAL

### MODEL NO.'s

**HPD-16  
HPD-20**

#### WHEN ORDERING REPAIR PARTS, ALWAYS GIVE THE FOLLOWING INFORMATION:

1. PART NUMBER
2. PART DESCRIPTION
3. MODEL NUMBER
4. NAME OF ITEM

FEBRUARY 2000

***Please work, drive, play and live each day with care and concern for your safety and that of your family and fellow citizens.***

**MAKE EVERY DAY  
A HOLIDAY  
FROM ACCIDENTS**

#### LIMITED WARRANTY

W orksaver warrants its implements, parts and accessories to be free from defects in materials and workmanship for a period of twenty-four (24) months from date of purchase. Upon written approval, W orksaver will repair or exchange without charge any part, which upon examination by W orksaver or its authorized agent, shall disclose to be defective.

This does not apply to (1) parts that have worn out in normal use, (2) parts broken because of improper assembly or operation by the customer, (3) parts accidentally damaged, (4) failure of parts traceable to improper care, (5) parts failing through use of implement for purposes other than those for which it was designed.

The obligations assumed by W orksaver and the limitations expressed herein are in lieu of all other warranties expressed or implied.

**W O R K S A V E R , I N C .**

**P.O. BOX 100 LITCHFIELD, IL 62056-0100 (217) 324-5973**

**WEB: <http://www.worksaver.com> E-MAIL: [sales@worksaver.com](mailto:sales@worksaver.com)**